

# ACCESSORIES

# SPECIFICATION SHEET

## Performance –

Fill in and send to Kansas City Deaerator or request a detailed specification sheet. Add additional thermal cases as needed.

PROJECT	OPERATING CONDITIONS	SPECIAL REQUIREMENTS
DEAERATOR	Operating Pressure	Post Weld Heat Treatment
Quantity	FEEDWATER INLET	Minimum Radiography
Capacity	% Makeup	WFIMP Testing
DESIGN	MU Temperature	HEI
ASME SEC. VIII, DIV. 1	%Condensate	BF PUMPS
Design Pressure	Cond. Temperature	Quantity
Full Vacuum Design	STORAGE CAPACITY	Capacity
Design Temperature	Minutes at Overflow	TDH
Corrosion Allowance	Gallon at Overflow	

## Accessories –

Select package or individual items

ITEM	DESCRIPTION	ACC PKG	PUMP PKG	SELECT
A	WATER INLET			
A1	Inlet Valve			
	Mechanical	STD	STD	
	Pneumatic	OPT	OPT	
A2	Level Controller	STD	STD	
	Level Transmitter	OPT	OPT	
A3	Inlet Valve Bypass Valves	OPT	STD	
A4	Inlet Valve Bypass Piping	OPT	STD	
A5	Inlet Valve Bypass Strainer	OPT	STD	
B	STEAM CONTROL			
B1	Steam PRV		OPT	
	Self Contained	OPT	OPT	
	Pneumatic	OPT	OPT	
B2	Steam PRV Controller	OPT	OPT	
B3	Steam PRV Bypass Valves	OPT	OPT	
B4	Steam PRV Bypass Piping	OPT	OPT	
B5	Steam PRV Bypass Strainer	OPT	OPT	
C	RELIEF VALVE			
C1	Relief Valve		STD	
	Sentinel	STD	STD	
	Full	OPT	OPT	
C2	Relief Valve Exhaust Piping	OPT	OPT	
D	THERMOMETER			
D1	(2) 5" Thermometer w/ss wells	STD	STD	
E	PRESSURE GUAGE			
E1	(1) 4-1/2" Pressure Gauge	STD	STD	
E2	Siphon & Cock	STD	STD	
E3	Pressure Transmitter	OPT	OPT	
F	VENT			
F1	Vent Valve	STD	STD	
F2	Vent Orifice w/Flange	OPT	OPT	
F3	Vent Bypass Valves	OPT	OPT	
F4	Vent Bypass Piping	OPT	OPT	
H	VACUUM BREAKER			
H1	Vacuum Breaker	STD	STD	

ITEM	DESCRIPTION	ACC PKG	PUMP PKG	SELECT
M	BFP RECIRC			
M1	BFP Recirc Shutoff	NA	OPT	
M2	BFP Recirc Check	NA	OPT	
M3	BFP Recirc Orifice	NA	OPT	
M4	BFP Recirc ARC Valve	NA	OPT	
M5	BFP Recirc Pressure Gauge	NA	OPT	
N	BFP SUCTION			
N1	BFP Pumps			
	(2) 100% Capacity	NA	STD	
	(3) 50% Capacity	NA	OPT	
	Motors			
	ODP	NA	STD	
	TEFC	NA	OPT	
N2	BFP Suction Isolation Valve	NA	STD	
N3	BFP Suction Strainer	NA	STD	
N4	BFP Suction Piping	NA	STD	
N5	BFP Suction Expansion Joint	NA	STD	
N6	BFP Discharge Pressure Gauge	NA	OPT	
N7	BFP Discharge Check Valve	NA	OPT	
N8	BFP Discharge Isolation Valve	NA	OPT	
O	CHEMICAL FEED			
O	Chemical Feed Quill		OPT	
Q	OVERFLOW			
Q1	Overflow Valve/Trap	STD	STD	
Q3	Overflow Piping	OPT	STD	
R	LEVEL SWITCH			
R1	Level Switches			
	High & Low (TWO)	STD	STD	
	High High (ADDITIONAL)	OPT	OPT	
R2	Level Switch Bridle Piping	OPT	STD	
S	GAUGE GLASS			
S1	Gauge Glass			
	Red Line Pyrex	STD	STD	
	Reflex	OPT	OPT	
	Magnetic	OPT	OPT	
S2	Gauge Glass Bridle	OPT	STD	

**Kansas City Deaerator Company**

6731 West 121<sup>st</sup> Street, Overland Park, KS 66209  
Tel (913) 338-2111 Fax (913) 338-2144  
Website: [www.deaerator.com](http://www.deaerator.com) Email: [info@deaerator.com](mailto:info@deaerator.com)

Copyright © January 2004



Standard Deaerating Units

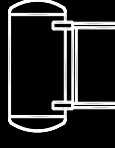

**HS Series**

Up to 350,000 #/hr  
Low Headroom



**TC Series**

Up to 250,000 #/hr  
Tray Unit Meets HEI



**BDS Series**

Up to 250,000 #/hr  
Tray Unit Meets HEI

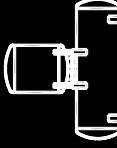

**DS Series**

Up to 800,000 #/hr  
Tray Unit Meets HEI



**VS & VT Series**

Up to 800,000 #/hr  
Tray Unit

Minimal Plan Area Meets HEI

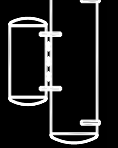

**HH Series**

Up to 16,000,000 #/hr  
Tray Unit-Meets HEI

Accessories

# KANSAS CITY DEAERATOR

## ACCESSORIES

Kansas City Deaerator can provide accessories to complete the deaerator as a turnkey system. Typical systems include pressure and temperature monitoring, level control, pressure control, boiler feed pumps, boiler feed pump recirculation and control panels. Mechanical, pneumatic or electronic accessories can be utilized to interface with existing plant control systems.

### TYPICAL P & ID

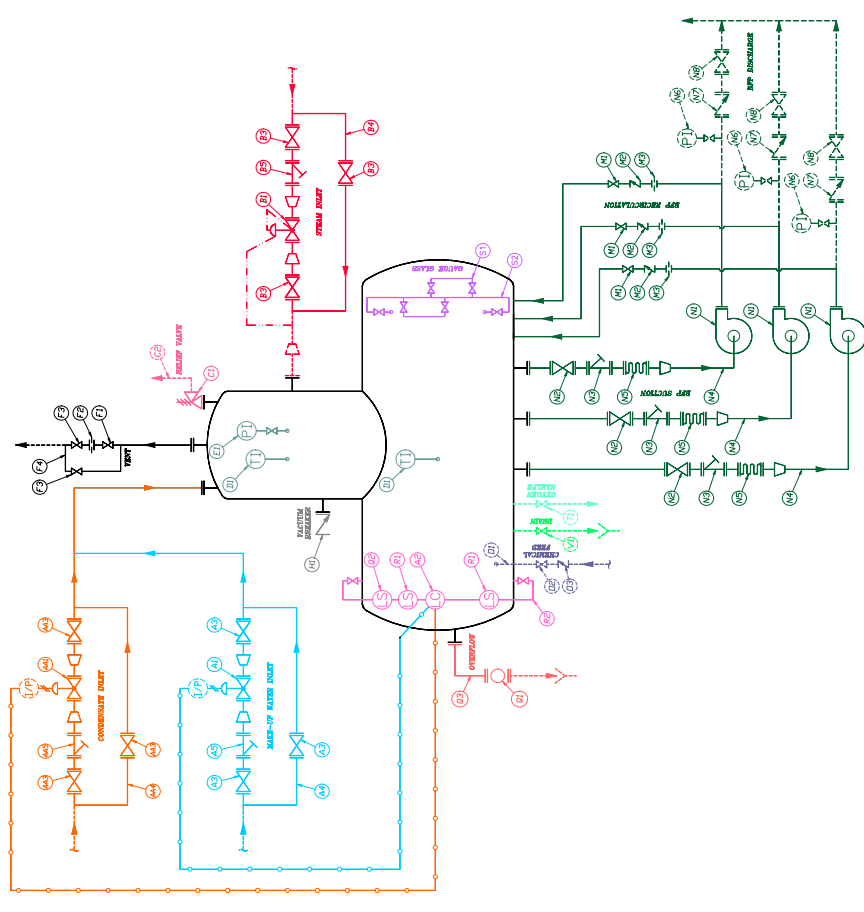

LEGEND

	CHECK VALVE		THERMOMETER		THERMOCOUPLE
	DATE VALVE		PRESSURE TRANSMITTER		LONG DASHED LINE INDICATES MECHANICAL CONNECTION/LINAGE
	GLOBE VALVE		PRESSURE CONTROLLER		HATCHED LINE INDICATES ELECTRICAL SIGNAL
	BUTTERFLY VALVE		LEVEL CONTROLLER		PNEUMATIC SIGNAL
	RELIEF VALVE		LEVEL SWITCH		PUMP
	FLEX PIPE		RESTRICTION ORIFICE		TRANSUCER
	RESTRICTION ORIFICE				
	FLUX PIPE				
	TRANSUCER				

DASHED LINE INDICATES BY OTHERS  
LONG DASHED LINE INDICATES MECHANICAL CONNECTION/LINAGE  
HATCHED LINE INDICATES ELECTRICAL SIGNAL  
PNEUMATIC SIGNAL





### Relief Valve

One or more relief valves are provided to either protect the pressure vessel against over-pressurization or act as sentinel relief. Overpressure can occur upon a failure of the steam pressure reducing valve, single or multiple trap discharges entering the deaerator or other conditions. It is the responsibility of the purchaser to evaluate all possible conditions and determine the worst case scenario for sizing the relief valve. If sentinel relief is selected by the customer for the deaerator, safety relief must be provided elsewhere in the system. When sentinel relief is selected, a nominally sized sentinel relief valve will be provided unless HEI is specified, in which case, sizing will be per HEI standards. The relief valve(s) are set to relieve at the deaerator design pressure.

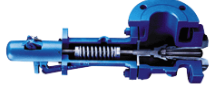

### Level Switches

Level switches are utilized for warning of high or low water levels, actuating a pneumatic overflow valve, and/or for boiler feedpump cutoff. Audible or visible alarms may be specified if desired. As a minimum the switches shall have the following characteristics:

- Housings will be general purpose NEMA-1;
- Switch ratings shall be 10 amps 120 VAC/DC;
- Switch action shall be SPST.
- Other housings, ratings, and actions may be specified.
- Mercury or non-mercury switches may be specified.



### Pressure Gauge

A pressure gauge is provided for the steam space in the deaerator. A typical gauge would be 4 1/2" dial (minimum) type with stainless steel bourdon tube construction. Either dry or liquid filled gauges may be specified. A siphon tube and shutoff cock for mounting the pressure gauge is included. In addition to considering the operating pressure of the deaerator, the gauge resolution (graduations) should be evaluated when selecting the pressure range of the pressure gauge.



### Thermometer

Thermometers, when properly located, give a visual indication of deaerator performance. Preferred locations are the steam space of the deaerator, and under the water level in the storage area. Gauges are 5" dial (minimum) bimetal with stainless steel thermowells. Gauges should be constructed with adjustable viewing angle, hermetically sealed and with a stem length consistent with the location of the gauge in the deaerator. In addition to consideration of the operating temperature of the deaerator, the gauge resolution (graduations) should be evaluated when selecting the temperature range of the thermometer.

### Control valves

Control Valves are typically used to control the inlet water flow from one or more sources. The valve size depends on the required flow rate, temperature, and valve inlet and outlet pressures. The valve shall be modulating type with stainless steel trim and can be specified as mechanical, pneumatic or electronic. An external float cage and lever actuator are provided for a mechanically operated valve. For pneumatic control, a pneumatic actuator and caged displacer level controller are provided. If electronic control is specified, an I/P positioner on the valve to accept a 4-20 ma input and a level transmitter are required.

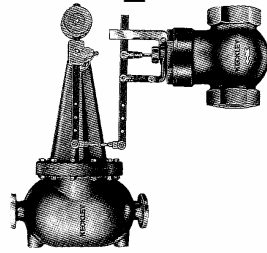

**Mechanically Operated Valve**



**Valve and actuator for pneumatic or electric control**



### Overflow Valves

Overflow valves are used to protect against high water level in the storage area. This device can be a float trap or a control valve sized to relieve the full capacity of deaerator.

### Gauge Glass

Gauge glasses are used to visually indicate the liquid level in the storage tank. The glass consists of a water column with shutoff valves to cover 10%-90% of the water level in the storage section. Glass can be specified as tubular red line pyrex, reflex or magnetic type. The gauge glass should be rated for the operating temperature and pressure of the deaerator.



**Red line pyrex gauge glass with shutoff valves**



**Magnetic gauge glass**

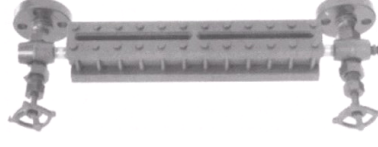

**Reflex type gauge glass**

### Other Instruments and Accessories

In addition to those shown here, Kansas City Deaerator can provide a wide variety of transmitters, controllers and other items. Consult with the factory for specialized applications.